



Modular, compact Inline Flow Meter

for compressed air and gases



measuring
•
monitoring
•
analysing

KME



- Measuring range air:
0.2 - 76.3 ... 2,2 - 848,2 Nm³/h
- Accuracy:
± 3 % of reading + 0,3 % of full scale
- p_{max}: 16 bar/PN16
- Temperature: -20 ... +60 °C
- Connections: BSP and NPT
Thread material: aluminium
- Pulse, analogue, switching output
- Optional display
- Modular design



SS

KOBOLD companies worldwide:

AUSTRALIA, AUSTRIA, BELGIUM, BULGARIA, CANADA, CHINA, CZECHIA, FRANCE, GERMANY, GREAT BRITAIN, HUNGARY, INDIA, INDONESIA, ITALY, MALAYSIA, MEXICO, NETHERLANDS, PERU, POLAND, REPUBLIC OF KOREA, RUSSIA, SPAIN, SWITZERLAND, THAILAND, TUNISIA, TURKEY, USA, VIETNAM

KOBOLD Messring GmbH
Nordring 22-24
D-65719 Hofheim/Ts.
☎ Head Office:
+49(0)6192 299-0
+49(0)6192 23398
✉ info.de@kobold.com
www.kobold.com

Description

The flow meter KME is dedicated for accurate metering and monitoring of compressed air and technical gases. For pipe diameters from DN15 (1/2") to DN50 (2"), there are 2x mounting blocks available.

The thermal measuring principle and the well-proven hot film sensor element lead to best long-term stability and fast response time.

Outstanding measuring accuracy, even in the lower measuring range is achieved by an application-specific multi-point factory adjustment, which is performed at 7 bar. This allows reliable leak detection and corresponding energy savings. The construction is optimised for easy installation and maintenance.

The KME is user configurable and can be easily adapted to any measuring task. The configuration can be set either using the optional display and push buttons or with the free configuration software.

KME Modular Design

One and the same transmitter can be used for each of three pipe diameters:

KME-715/-720/-725: DN15 (1/2"), DN20 (3/4") and DN25 (1")

KME-732/-40/-50: DN32 (1-1/4"), DN40 (1-1/2") and DN50 (2")

The pipe diameter is easily changed via the display menu or the configuration software.

Once the gauge mounting block is built into the pipeline, the transmitter can be installed and removed without disassembling the pipework. As a result, the KME is also ideal for temporary measurement at several mounting blocks. The sealing plug included in the scope of supply enable the normal operation of the compressed air system when the transmitter is removed.

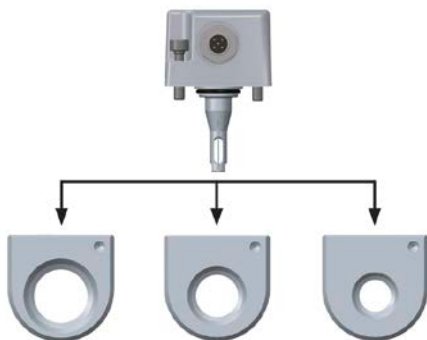

Display (optional)

The state-of-the-art LCD shows the current measured values and the overall consumption. The user specific device setup can be easily performed with the push buttons and intuitive menu guidance.

The display can be rotated in 90° increments with a push button for convenient orientation in any mounting position of the flowmeter.

The KME without display can be configured by the user via USB interface with the free configuration software.

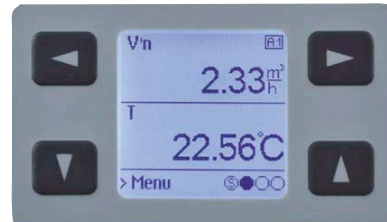

Applications

- Compressed air consumption measurement
- Flow measurement of technical gases (N₂, Ar, CO₂)
- Nitrogen generators
- Leak detection

Technical Details

Measuring values

Flow

Measuring units: m³/h, m³/min, l/min, l/s, kg/h, kg/min, m/s, SCFM, ft/min, °C, °F

Standard conditions

factory setting: 1013.25 mbar, 0°C (configurable)

Measuring range in air¹⁾: DN 15: 0.2 ... 76.3 Nm³/h
 DN 20: 0.4 ... 135.6 Nm³/h
 DN 25: 0.6 ... 212 Nm³/h
 DN 32(1-1/4"): 0.9 ... 347.4 Nm³/h
 DN 40 (1-1/2"): 1.4 ... 542.8 Nm³/h
 DN 50 (2"): 2.2 ... 848.2 Nm³/h

Accuracy²⁾
 (in air at 7 bar [abs.]
 and 23 °C):

± 3% of reading +
 ± 0.3% of full scale

Temperature coefficient: ± 0.25% of reading / °C deviating from 23 °C

Pressure coefficient³⁾: + 0.5% of reading / bar deviating from 7 bar

Response time t₉₀: < 2 s

Measuring rate: 0.1 s

Temperature

Measuring range: -20 ... 60 °C

Accuracy
 (at 20 °C and
 flow > 0,5 Nm/s): ± 0.7 °C

Outputs

Analogue output
 (scaleable): 0 - 20 mA or 4 - 20 mA R_L < 500 Ω

Switching output: DC PNP, max. 100 mA, V_{drop} < 2.5 V
 configurable: N/C or N/O,
 hysteresis, window

Pulse output: consumption meter,
 pulse length 0.02 ... 2 s

Consumption interface: USB

Technical Details (continuation)

General

Power supply:	18 - 30 V _{DC}
Current consumption (max.):	120 mA or 2.5 W (with display) 60 mA or 1.6 W (without display)
Operation pressure (max.):	16 bar / PN 16
Ambient temperature:	0 ... 50 °C (with display) -20 ... 60 °C (without display)
Medium and storage temperature:	-20 ... 60 °C
Humidity:	0 ... 100 % rH, non-condensing
Medium:	compressed air, nitrogen, CO ₂ , argon
Electrical connection:	plug M12x1 4-pol.
Electromagnetic compatibility:	EN61326-1 industrial environment, EN61326-2-3

Material

Housing:	polycarbonate
Sensor tube:	stainless steel 1.4404
Sensor head/ sensor element:	stainless steel 1.4404 / glass
Mounting block:	anodised aluminium
Protection housing:	IP 65
Display (optional):	current value and consumption, 90° rotatable, intuitive operation

¹⁾ Factory setting of the output see manual.

²⁾ The tolerance specifications include the uncertainty of the factory calibration with a coverage factor k=2 (2 x standard deviation). The tolerance was calculated in accordance with EA-4/02 following the GUM (Guide to the Expression of Uncertainty in Measurement).

³⁾ The flowmeter is factory adjusted at 7 bar (abs). At operating pressure other than 7 bar (abs), the error can be corrected by entering the actual system pressure (via display menu or with configuration software).

Features

Transmitter

- For each three pipe diameters
- Installation and removal without disassembling the pipework facilitates regular calibration
- Application-specific adjustment under pressure for best accuracy

Sensor head and thermal flow sensor

- Robust design in stainless steel
- Very short response time
- Wide measuring range
- Long-term stable and accurate
- Negligible pressure drop
- Highly insensitive to contamination
- No additional pressure and temperature compensation required

Gauge mounting block

- Precise and reproducible positioning of the transmitter for best accuracy
- Aluminum or stainless steel
- Can be operated with sealing plug also without transmitter

Display (optional)

- Shows instantaneous values and overall consumption
- Intuitive device setup with push buttons
- Can be rotated in 90° increments

Output

- User configurable via display or PC
- 0-20 mA / 4-20 mA output
- Two switch outputs
- Pulse output

Measurands

- Standard volume flow
- Mass flow
- Standard flow
- Temperature
- Integrated consumption meter (totalisator) for cost-effective consumption analysis without additional datalogger

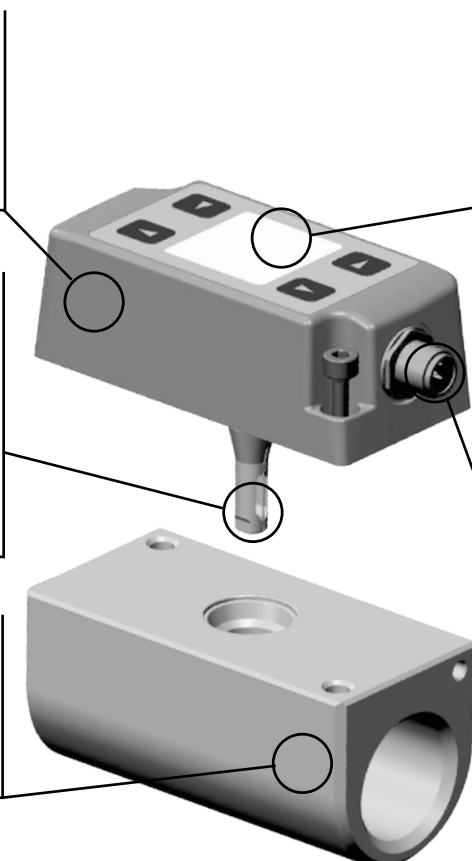



Connection

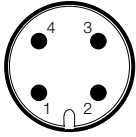

Analogue/switching/
pulse output
1... V+
2... Output 1
3... GND
4... Output 2

M12 plug on device

The output signal is freely selectable and scalable by the user:

Output 1: Analogue [mA] or switching output

Output 2: Pulse output or switching output

Order Details (Example: **KME-715R0L1NQ2**)

Model	Material mounting block	Measuring range/mounting block	Connection	Display	Gas type
KME-	7 = aluminium	15 = 0.2 ... 76.3 Nm ³ /h (air), DN 15 20 = 0.4 ... 135.6 Nm ³ /h (air), DN 20 25 = 0.6 ... 212 Nm ³ /h (air), DN 25 32 = 0.9 ... 347.4 Nm ³ /h (air), DN 32 40 = 1.4 ... 542.8 Nm ³ /h (air), DN 40 50 = 2.2 ... 848.2 Nm ³ /h (air), DN 50	R = BSP thread N = NPT thread	0 = without display 1 = with display	L = air N = nitrogen C = CO ₂ A = argon

Order Details (continuation)

Unit	Physical size output 1	Physical size output 2	Output 1/Output 2
1 = SI units 2 = US units	N = Standard volume flow (standard) T = Temperature (°C) M = Mass flow (kg/h) V = Standard flow (Nm/s)	Q = consumption (standard)	2 = switching /counting pulse output 3 = analogue output 0-20 mA/counting pulse output 4 = analogue output 4-20 mA/counting pulse output (standard)
		T = Temperature M = Mass flow (kg/h) V = Standard flow N = Standard volume flow	1 = 2x switching output 7 = analogue output 0-20 mA/switching output 8 = analogue output 4-20 mA/switching output

Dimensions [mm]

KME-715/-720/-725

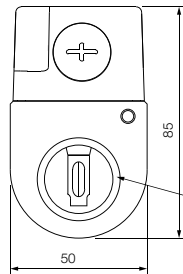
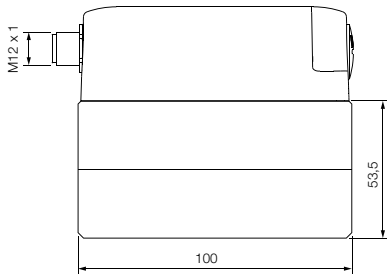

Internal thread:
Whitworth thread according to EN 10226
(old DIN 2999) or NPT

KME-732/-740/-750

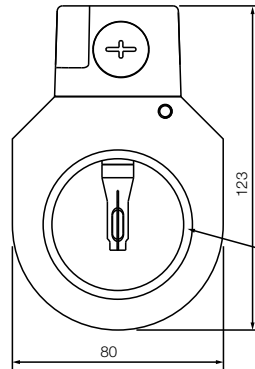
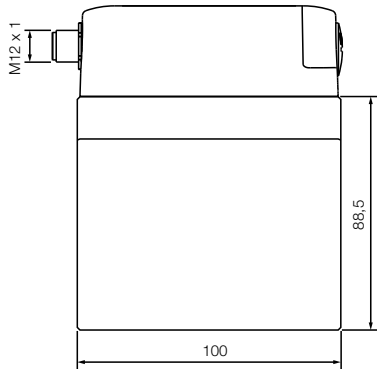

Internal thread:
Whitworth thread according to EN 10226
(old DIN 2999) or NPT

Mounting block	Thread R _p or NPT
DN 15	1/2"
DN 20	3/4"
DN 25	1"
DN 32 ¹⁾	1 1/4"
DN 40	1 1/2"
DN 50	2"

¹⁾ Only R_p thread

Scope of Supply

- KME according to order details
- 1 x Allen key
- 1 x USB cable
- Instruction manual
- Calibration certificate
- Gauge mounting block incl. sealing plug