



Operating Instructions for All Metal Flow Switch

Model: SMN



1. Contents

1. Contents	2
2. Note	3
3. Instrument Inspection	3
4. Regulation Use	3
5. Operating Principle	4
6. Use in Hazardous Areas	4
6.1. General	4
6.2. Electrical Contacts	5
6.3. Potential Equalisation	5
7. Mechanical Connection	5
8. Electrical Connection	6
8.1. with Plug Connection	6
8.2. Example for Contact Protective Measures	6
9. Commissioning	7
10. Maintenance and Care	7
11. Technical Information	8
12. Order Codes	9
13. Dimensions	9
14. Pressure Loss Diagram	10
15. Declaration of the Manufacturer	10
16. EU Declaration of Conformance	12

Manufactured and sold by:

Kobold Messring GmbH
Nordring 22-24
D-65719 Hofheim
Tel.: +49(0)6192-2990
Fax: +49(0)6192-23398
E-Mail: info.de@kobold.com
Internet: www.kobold.com

2. Note

Please read these operating instructions before unpacking and putting the unit into operation. Follow the instructions precisely as described herein.

The devices are only to be used, maintained and serviced by persons familiar with these operating instructions and in accordance with local regulations applying to Health & Safety and prevention of accidents.

When used in machines, the measuring unit should be used only when the machines fulfil the EC-machine guidelines.

as per PED 2014/68/EU

In acc. with Article 4 Paragraph (3), "Sound Engineering Practice", of the PED 2014/68/EU no CE mark.

Table 8, Pipe, Group 1 dangerous fluids

3. Instrument Inspection

Instruments are inspected before shipping and sent out in perfect condition. Should damage to a device be visible, we recommend a thorough inspection of the delivery packaging. In case of damage, please inform your parcel service / forwarding agent immediately, since they are responsible for damages during transit.

Scope of delivery:

The standard delivery includes:

- All Metal Flow Switch model: SMN
- Operating Instructions

4. Regulation Use

Model SMN instruments monitor liquid flows. Only clean and homogeneous liquids of low viscosity - against which the instrument materials are resistant - should be monitored. Large switch-point inaccuracies can occur with highly viscous media.

Large dirt particles can block the float and thus cause faulty signals. Pieces of ferrite, deposited on the float (with embedded magnet) can lead to the same effect (we recommend magnetic filters).

5. Operating Principle

The KOBOLD model SMN flow switch is used when extremely low flow switch points are required in combination with minimum pressure loss at high flow rates.

The flow switch operates on the well-known float principle. An orifice float with an integrated circular magnet moves within a cylindrical flow tube in the direction of the flow and against a spring.

The magnetic field of the float activates a reed contact which is mounted on the outside of the instrument in a sliding protective casing. Due to the special construction of the float and flow tube only a low flow is required to raise the float and hence to activate the reed contact. If the flow rate increases further and the float reaches the top of its travel an additional flow path opens allowing high flow rates without a significant increase in the pressure loss.

6. Use in Hazardous Areas

6.1. General

The All Metal Flow Switch does not have a potential igniting source of his own as a mechanical operating resource; **it does not get any identification according to the guideline 94/9/EC ("ATEX 100a")**.

The add-on control contacts can under application of EN 60079-14 be used as a "simple operator" (simple electrical equipment) without other marking in intrinsically safe equipment. The following limit values for the switching contact should not be exceeded: $U = 30 \text{ VDC}$, $I = 100 \text{ mA}$, $P = 1,2 \text{ W}$. It does not get any identification according to the ATEX-guideline.

The units can be used as follows:

- a) In the Zone 2 (Gas-Ex, Cat. 3G) into explosion group of IIA, IIB and IIC
- b) In the Zone 22 (Dust-Ex, Category 3D) at non-conductive dusts with a minimum igniting energy of $> 3 \text{ mJ}$
- c) In the Zone 1 (Gas-Ex, Cat. 2G) into explosion group of IIA, IIB and IIC
- d) In the Zone 21 (Dust-Ex, Category 2D) at non-conductive dusts with a minimum igniting energy of $> 3 \text{ mJ}$

The Flow Switch is filled completely with medium in the normal operation. Zone 2 or zone 1 conditions may be obtained for a short time.

The ambient temperature limit area is fixed as follows:

Execution	Medium Temperature	P _{max}
SMN-11...	-20...+100 °C	250 bar
SMN-12...	-20...+100 °C	350 bar

6.2. Electrical Contacts

The Flow Switch can be used in the Ex-area according Category 2G and 2D Cluster II; in zone 1 and 21 in connection with a switching amplifier for protection type Ex II (2)GD [EEx ia] IIC (intrinsically safe)

The electrical connection is explained in section 8. Electrical Connection.

6.3. Potential Equalisation

The All Metal Flow Switches have to be included in the equipotential bonding system of the installation. This is done by the connection tube made out of metal.

7. Mechanical Connection

- Make sure that allowed max. operating pressure and temperature are not exceeded.
- The instrument can be installed vertically or horizontally in the pipework. Flow is in the direction of the arrow from bottom to top, from left to right or from right to left.
- Remove all transport restraints and make sure that none of the packing material remains in the instrument.
- Use Teflon tape or something similar to seal the threaded connections.
- The instruments should not be installed in an induction field.
- If possible, check after mechanical installation that the threaded joint/pipe connection is tight and leakproof.

8. Electrical Connection

8.1. with Plug Connection

- Make sure that the electrical supply lines are powerless.
- Undo the locking screw on the plug cap and remove the cap from the base.
- Mount supply line in the plug cap as shown in the wiring diagram.
- The contact is adjusted and should not be modified.
- Insert the plug connector on the contact stem and fix it with the retaining screw.

N/O contact

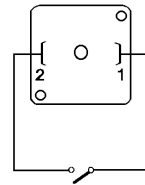

Changeover contact

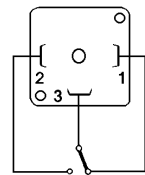

Attention! Every single specified electrical value for the sealed contact should not be exceeded even for short periods. We recommend contact protection relays or other contact protection measures for higher switching values.

When the external devices have been connected to the limit contact and the switching point has been set, the electrical connection is complete. The instrument can now be put into operation.

8.2. Example for Contact Protective Measures

For capacitive and inductive loads (long conductors and relay/protection) we recommend the following protective schemes.

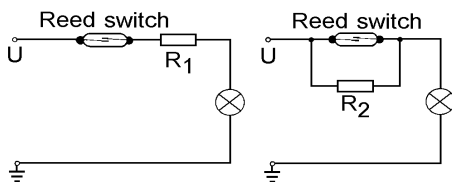

Lamp load with parallel or series resistance to the switch.

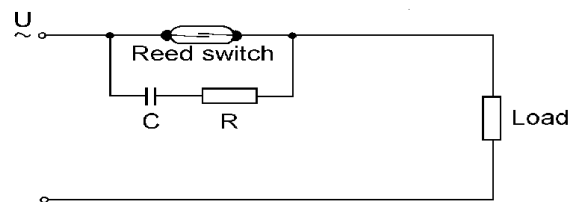

Protection with an RC circuit for a.c. current and inductive load.

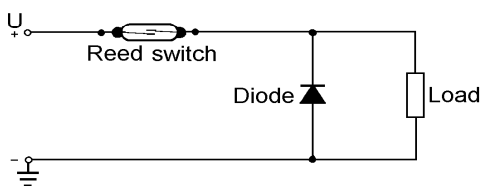

Protection with an idle diode for d.c. current and inductive load.

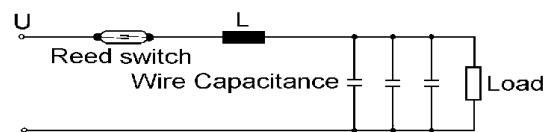

Protection against high discharge from condensers and load capacitances.

9. Commissioning

When used in machines according to guideline 2006/42/EC commissioning is prohibited until it is established that the machine meets the general requirements of the guideline.

The limit switch is adjusted.

10. Maintenance and Care

The instrument needs no maintenance when the measured medium is not polluted. Lime and other deposits should be removed regularly from the inside parts of the instruments. The instrument **cannot** be taken apart and must be cleaned with a suitable cleanser.

11. Technical Information

Housing:	SMN-11...: brass, Ms 58 SMN-12...: stainless steel, 1.4301
Float:	SMN-11...: brass, Ms 58 SMN-12...: stainless steel, 1.4301
Cage:	SMN-11...: brass, Ms 58 SMN-12...: stainless steel, 1.4301
Spring:	stainless steel
Magnets:	Ceramic
Max. temperature:	100 °C
Max. pressure:	SMN-11...: 250 bar SMN-12...: 350 bar
Installation position:	horizontal or vertical (upward direction), flow in direction of the arrow
Contact components:	1 bistable reed contact N/O contact, changeover contact,
Electrical connection:	Connector DIN 43 650
Electrical switching values:	N/O contact (standard) max. 250 V _{AC/DC} / 1,5 A / 100 W / 100 VA changeover contact (Standard) max. 250 V _{AC/DC} / 1 A / 30 W / 60 VA N/O contact and changeover contact (cCSAus) max. 230 V _{DC} / 0,26 A / 60 W, 60 V _{DC} / 1 A / 60 W max. 240 V _{AC} / 0,42 A / 100 W, 100 V _{AC} / 1 A / 100 W
Ex-range:	ATEX-Zone 1 as "simple operator"
Accuracy:	± 5% f. s.
Protection type:	IP 65

12. Order Codes

Order Details (Example: SMN-1150H R0 R 25)

Function	Brass version	Stainless steel version	Type of contact	Connection
Max Flow: 100 l/min Fix Switch point at approx. 1l/min with falling flow rate	SMN-1150 H...	SMN-1250 H...	..R0.. = 1 N/O contact ..U0.. = 1 changeover contact ..C0.. = 1 N/O contact (cCSAus) ..D0.. = 1 changeover contact (cCSAus)	...R25 = G1 female ...N25 = 1 NPT female

13. Dimensions

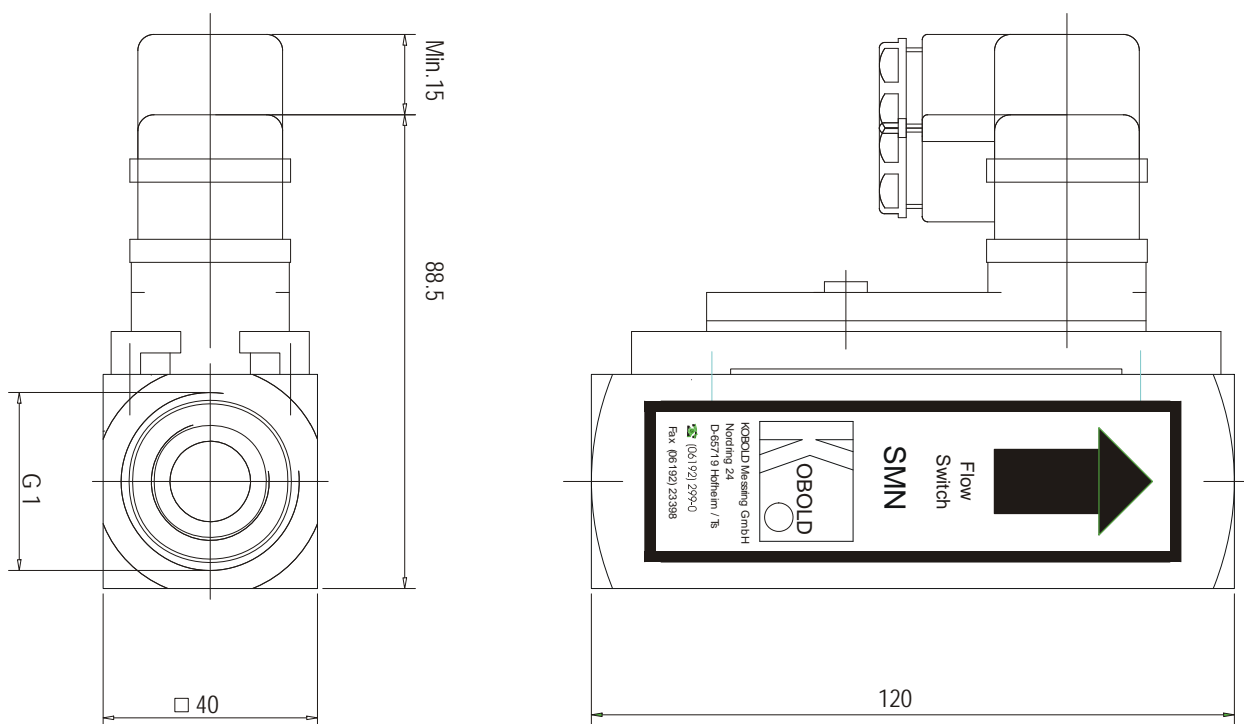

14. Pressure Loss Diagram

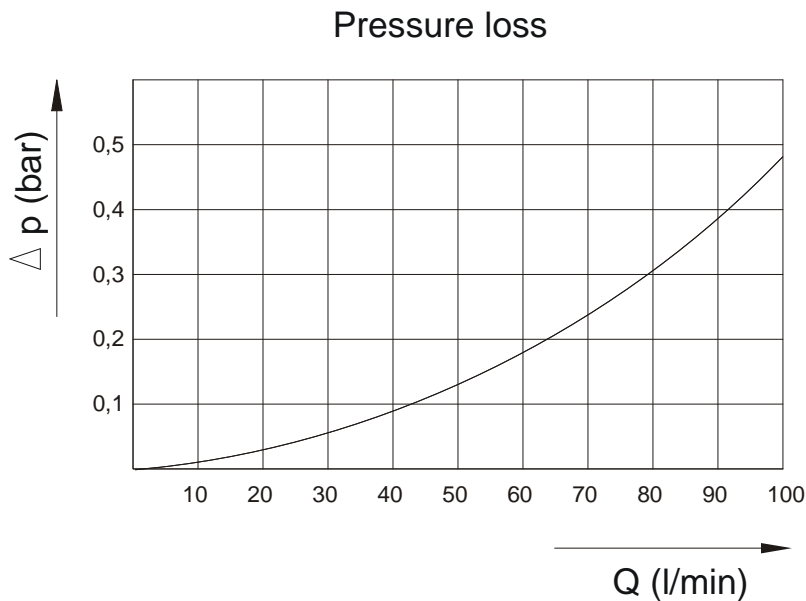

15. Declaration of the Manufacturer

Declaration for equipment without a potential igniting source according to the explosion protection guideline 94/9/EC (ATEX 95).

We, KOBOLD Messring GmbH, herewith declare that the following units and/or assembly groups:

All Metal Flow Switch of the model SMN

according to guideline 94/9/EG, article 1 paragraph 2 and 3 are

- a. no safety, controlling and regulating equipment,
- b. no devices,
- c. no protection systems and
- d. no components.

The Flow Switch does not have a potential igniting source of its own as a mechanical operating resource and/or does not carry any internal explosive atmosphere; it does not get **any identification** according to the ATEX guideline. An internal danger of ignition was accomplished.

The units / assembly groups can be used as follows:

- a. In the Zone 2 (Gas-Ex, Cat. 3G) into explosion group of IIA, IIB and IIC
- b. In the Zone 22 (Dust-Ex, Category 3D) at non-conductive dusts with a minimum igniting energy of > 3 mJ
- c. In the Zone 1 (Gas-Ex, Cat. 2G) into explosion group of IIA, IIB and IIC
- d. In the Zone 21 (Dust-Ex, Category 2D) at non-conductive dusts with a minimum igniting energy of > 3 mJ

The heating is negligible, a limit value of 20 K must be accounted for the ambient temperature and the temperature classification and/or the maximum surface temperature.

The following harmonised norms were used in the version current for the signature date.

- EN 1127-1 Potentially Explosive Atmosphere, Explosion Protection, part 1: Basics and Methodology

The operation instructions with the broader details listed within and the installation regulations for the potentially explosive atmosphere have to be definitely observed. Some essential measures are:

- a. The Flow Switch has to be involved in the equipotential bonding system.
- b. Add-on control contacts can under application of EN 60079-14 article 12.2.1 being used as simple electrical equipment without other marking in intrinsically safe equipment.

Hofheim, 16. Jan. 2007



H. Peters
General Manager



M. Wenzel
Proxy Holder

16. EU Declaration of Conformance

We, KOBOLD-Messring GmbH, Hofheim-Ts, Germany, declare under our sole responsibility that the product:

All Metal Flow Switch

model: SMN-...

to which this declaration relates is in conformity with the standards noted below:

EN 61010-1:2011

Safety requirements for electrical equipment for measurement, control and laboratory use - Part 1: General requirements

EN 60529:2014

Protection type through case (IP code)

Also the following EC guideline is fulfilled:

2014/35/EU
2011/65/EU

Low Voltage Directive
RoHS (category 9)

94/9/EG

Equipment and Protective systems intended for use in potentially Explosive Atmospheres (ATEX 100a)

Quality Management Production

Certificate number: BVS 15 ATEX ZQS / E 110

Notified body: Deutsche Montan Technologie

Identification number: 0158



H. Peters
General Manager



M. Wenzel
Proxy Holder

Hofheim, 27. April 2016